

Meter Relay Collection



2103

2104

Contents
1.Introduction	P.2
2.Overview	P.2
-1.Basic Specifications	P.2
-2.Features	P.4
-3.Connection Examples	P.4
-4.Meter Options	P.4
3.Names of Parts	P.5
4.Custom Specifications	P.6
-1.Starting Current Protection Circuit	P.6
-2.Relay Response Time Setting	P.6
-3.Recorder Connection Terminals	P.7
-4.Extended Scales	P.7
-5.Expanded Scales	P.7
-6.Manually Marked Scales	P.8
-7.Dual-Deflection Meters	P.8
-8.Supply Voltage	P.8
-9.Miscellanea	P.8



ISO 9001
JMI-0216



ISO14001
JQA-E-90091



www.hioki.com

HIOKI company overview, new products, environmental considerations and other information are available on our website.

1.Introduction

Hioki meter relays feature non-contact electronic setpoints.

Production of these high-precision, reliable and ultra-sensitive meter relays is realized by converting to electronic design.



The relay is energized whenever the measured electrical parameter causes the meter to deflect to a preset upper or lower limit.

Analog meter relay models 2101 and 2102, which have been popular for many years, have been succeeded by the 2103 and 2104, with improved safety.

A few specifications have been changed due to safety distances added around the power supply and input terminals on the rear of the relay, and from conductive materials around the meter cover.

2.Overview

-1.Basic Specifications

Appearance		
Model	2103	2104
Dimensions (mm)	84W×72H×133D	104W×88H×133D
Class	Class 2.5	Class 1.5

Setting

HL Type	Upper and Lower-limit
H Type	Upper-limit only
L Type	Lower-limit only

H indicator	Red
L indicator	Green

Units

DC	Voltmeter (DCV)	$\frac{mV}{\sim}$	$\frac{V}{\sim}$	$\frac{kV}{\sim}$
	Ammeter (DCA)	$\frac{\mu A}{\sim}$	$\frac{mA}{\sim}$	$\frac{A}{\sim}$
AC	Voltmeter (ACV)	$\frac{mV}{\sim}$	$\frac{V}{\sim}$	$\frac{kV}{\sim}$
	Ammeter (ACA)	$\frac{\mu A}{\sim}$	$\frac{mA}{\sim}$	$\frac{A}{\sim}$

Changes from Former Models

- Model names (2101 to 2103, and 2102 to 2104)
 - Appearance (around meter cover and terminals on the rear)
 - Specify supply voltage when ordering (Single voltage specification. Default 100 V AC, specify other voltage when ordering.)
 - Hioki logo display (lower left corner of scale panel)
 - Relay exchange not possible
 - External dimensions (extends about 17 mm behind mounting panel)
Panel mounting dimensions are unchanged
- Note.** If there is insufficient space due to the extra depth required when installing in an existing mounting location, please ask us for a separate spacer (if the protrusion is acceptable).

Specifications (for one year guaranteed accuracy)

Meter indicator shape	0.3 mm dia. needle
Setting accuracy	Within 1.5% of the maximum scale value (independent from the instrument section)
Dead-zone width	Within 0.5% of the scale length
Indicator operating range	Within the scale (passing system)
Setting indicator	Spear shape: H indicator (upper-limit side) Red L indicator (lower-limit side) Green
Setting indicator setting range	Within the scale for both H and L
Minimum H/L interval	Within 3% of the scale length
Delay time at power ON	Approx. 2 s (time constant)
Relay contact structure	One transfer for both H and L
Relay response time	Approx. 0.5 s
Relay contact capacity rating	5 A (250 V AC, 30 V DC resistive load)
Power source	100 V/200 VAC (to be specified at the time of ordering) 50 Hz/60 Hz (Voltage fluctuations of ± 10% from the rated supply voltage are taken into account.)

Standard Full-Scale Values

DC Ammeter		DC Voltmeter		Rectifying AC Ammeter		Rectifying AC Voltmeter	
Std. Full-Scale Value	Meter Sensitivity Spec	Std. Full-Scale Value	Meter Sensitivity Spec	Std. Full-Scale Value	Meter Sensitivity Spec	Std. Full-Scale Value	Meter Sensitivity Spec
1 μA	50 mV	10 mV	100 kΩ/V	200 μA	50 mV	50 mV	10 kΩ/V
10 μA		15 mV	100 kΩ/V	500 μA		100 mV	10 kΩ/V
20 μA		30 mV	100 kΩ/V	1 mA		150 mV	10 kΩ/V
50 μA		50 mV*	100 kΩ/V	2 mA		300 mV	10 kΩ/V
100 μA		100 mV	100 kΩ/V	5 mA		500 mV	1 kΩ/V
200 μA		150 mV	100 kΩ/V	10 mA		1 V	1 kΩ/V
500 μA		300 mV	100 kΩ/V	20 mA		1.5 V	1 kΩ/V
1 mA		500 mV	10 kΩ/V	50 mA		3 V	1 kΩ/V
2 mA		1 V	10 kΩ/V	100 mA		5 V	1 kΩ/V
5 mA		1.5 V	10 kΩ/V	200 mA		10 V	1 kΩ/V
10 mA		3 V	10 kΩ/V	500 mA		15 V	1 kΩ/V
20 mA		5 V	10 kΩ/V	1 A		30 V	1 kΩ/V
50 mA		10 V	10 kΩ/V	2 A		50 V	1 kΩ/V
100 mA		15 V	10 kΩ/V	3 A		100 V	1 kΩ/V
200 mA		30 V	10 kΩ/V	5 A*		150 V	1 kΩ/V
500 mA		50 V	10 kΩ/V			300 V	1 kΩ/V
1 A	100 V	10 kΩ/V					
2 A	150 V	10 kΩ/V					
5 A	300 V	10 kΩ/V					
10 A							
20 A							
Full-Scale: 4 - 20 mA	50 mV	Full-Scale: 1 - 5 V	10 kΩ/V				

● For full-scale values exceeding 20 A DC, use an external shunt with the indicated 50 mV (*1) meter
● For full-scale values exceeding 5 A AC, use an external CT with the indicated 5 A (*2) meter

Standard Scale Graduations

Full-Scale Value	Graduations	Graduation Illustration
1,10,100	50	
1.5,15,150	30	
2,20,200	40	
2.5,25,250	50	
3,30,300	30	
4,8,40	40	
5,50,500	50	
6,60,600	30	
7.5,75,750	37.5	

Dimensions

2103

2103 Metal Mounting Bracket Installation

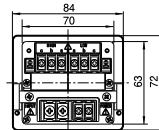
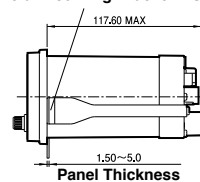

2103 Panel Cutout

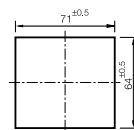

2104

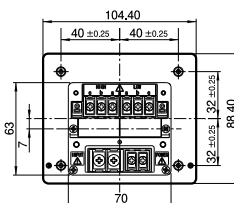
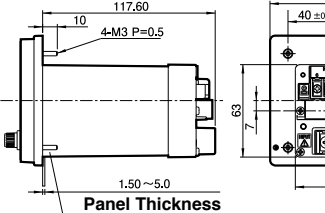

2104 Panel Cutout

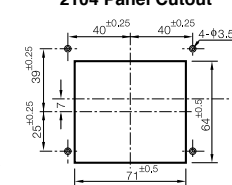

The 2104 mounts with nuts in 4 places

Setting and Relay Energizing Timing Chart

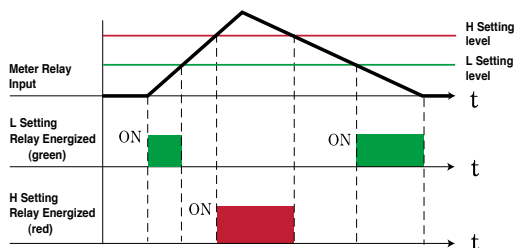

Contact Closure

■ Regions indicate ON, □ indicates OFF. (when using (a) - (c) contact terminals)

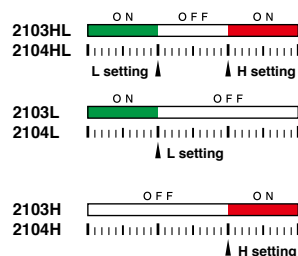

Terminal Configuration

[When power is off, same for 2103 and 2104]

Labels (1) and (2) below are attached to the back of the meters.

Label (2) shows custom specifications (not included in the standard specifications).

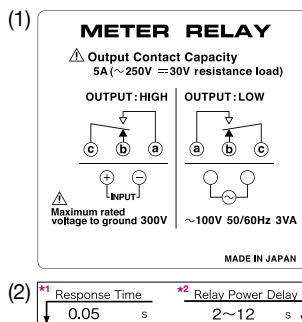

*1 Response Time (Relay response time): In this case, indicates a (custom) response time of 0.05 s. (See Relay Response Times on page 6-2.)

*2 Relay Power Delay (Power-on delay): In this case, indicates a (custom) relay power-on delay of 2 to 12 s. (See Starting Current Protection Circuit on page 6-1.)

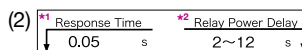

-2.Features

Relay Power-On Energizing Prevention Circuit

For about two seconds after turning meter relay power on, the delay characteristic prevents the relay from energizing. This prevents the relay from energizing during meter input device startup.

-3.Connection Examples

Motor Drive Overload Prevention

Motor Relay used: H-type AC ammeter with starting current protection

Supply voltage: 200 V AC

Note

- After wiring the terminals, confirm that adjacent power and signal wires do not touch.
- For safety when using a CT, ground the signal wire at one meter input terminal.

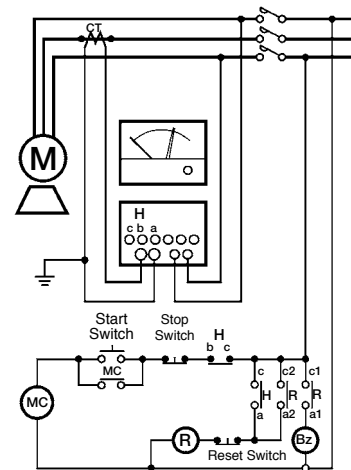

-4.Meter Options

EXTERNAL SHUNTS Model: HS-1 /30A, 50A, 75A, 100A, 150A, 200A, 300A

For use with 50 mV meters.

Example: In the 100 A DC case, connect an HS-1 (100 A) shunt as shown at the right.

Meter relay type used: 50 mV DC input, with 100 A DC scale

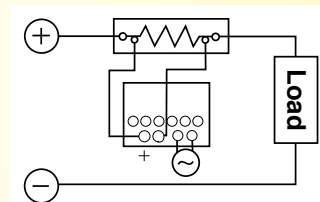

CURRENT TRANSFORMER Model: CT-5MRN /100:5A, 120:5A, 150:5A

For use with 5A meters.

Wrap N turns of conductor through the central hole, where N equals the maximum value of the CT primary current divided by the full-scale meter current.

In the 120:30 A case, the number of conductor turns through the central hole is $120/30 = 4$.

Example: For the 30 A AC case, use a CT-5MRN (with 120 A maximum primary current) as shown at the right, with 4 turns.

Meter relay type used: 5 A AC input, 30 A AC scale (CT30:5 A).

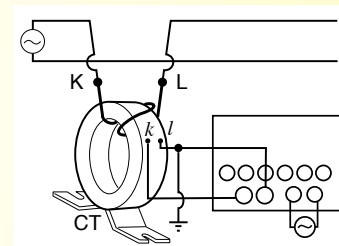

3.Names of Parts

Front Panel

2103
(HL Type)

Lower-limit operation LED
(Not on H type)

Upper-limit operation LED
(Not on L type)

Instrument indicator
L indicator

H indicator

Zero-adjustment dial

2104
(HL Type)

L Level-setting dial
(Not on H type. On the L type, located on the right side)

H level-setting dial
(Not on L type)

Zero-adjustment dial

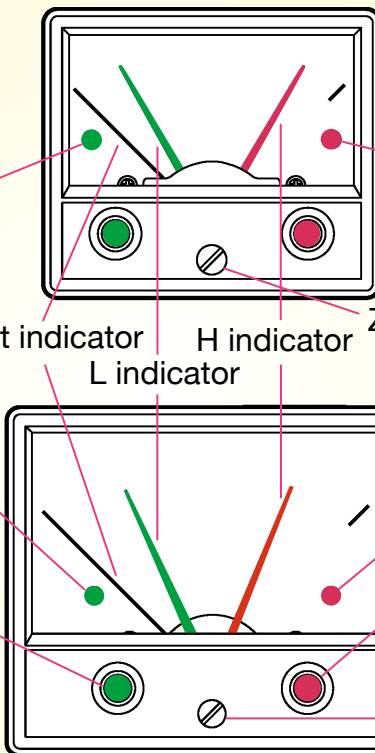

Rear Panel

2103
(HL Type)

Response Time Adjustment *

Start-Up Delay *
Adjustment

Recorder Output (+)*

Recorder Output (-)*

U-shaped mounting hardware

DC Input Polarity

DC Power Supply Polarity*

Input terminals (INPUT±) Power-supply terminals

2104
(HL Type)

H Relay Contact Output Terminals
(Not on L type)

L Relay Contact Output Terminals
(Not on H type)

Panel fastening screw
(4 places)

H relay
(Not on L type)

L relay
(Not on H type)

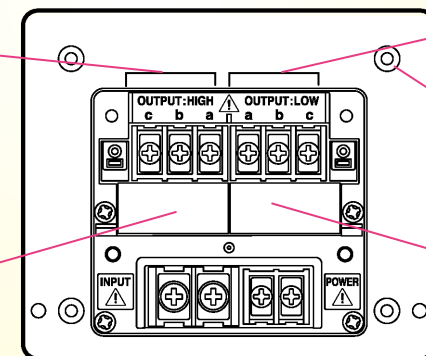

Input terminals (INPUT±) Power-supply terminals

* Indicates custom specification

H relay energizes when the input level exceeds the setting indicator (contacts a-c closed).
L relay energizes when the input level falls below the setting indicator (contacts a-c closed).

4. Custom Specifications

-1. Starting Current Protection Circuit (Relay Startup Delay)

Relay energizing needs to be inhibited to allow the necessary overcurrent when starting a motor. In this case, the delay characteristic needed to inhibit relay energizing can be provided by selecting or setting a specific relay power-on delay. If the required time is more than the nominal delay (about 2 seconds) when turning on the power supply, select this custom specification. For this circuit to operate properly, the meter power supply must be configured to turn on at the same time as the motor starting relay. (This configuration is required for any device that requires overcurrent upon power-on, not just motors.)



Note

When the starting current protection time is variable, adjust by turning the single-turn potentiometer in the hole on the back of the meter relay with a screwdriver. As there is no scale for this adjustment, adjust while testing the protection time with an actual load device. See page 5 for the adjustment location.

Specifications

Starting Current Protection Time Setting

- When Fixed: 5, 10, 15, 20, 30, or 60 seconds
- When Variable:
 - For DC input, adjustable from about 0.1 to 10 s.
 - For AC input, adjustable from about 2 to 12 s.

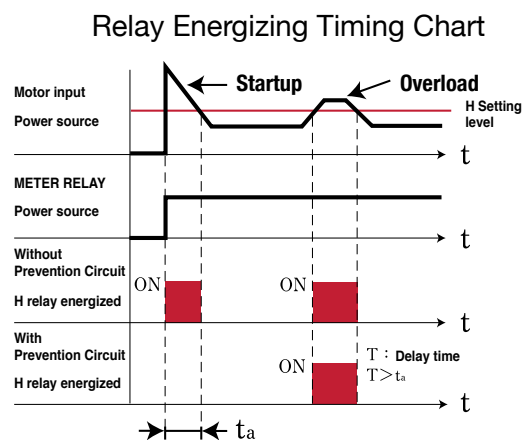

-2. Relay Response Time Setting

Standard relay energizing time is set to about 0.5 s (time constant) to suit deflection of the meter's indicating pointer. This relay energizing speed can be adjusted to be faster or slower.



Note

When the response time is variable, adjust by turning the single-turn potentiometer in the hole on the back of the meter relay with a screwdriver. As there is no scale for this adjustment, set while testing the response time with an actual load device. See page 5 for the adjustment location.

Specifications

- When Fixed: For DC input, fixed at 0.05 s
 - When Variable:
 - For DC input, adjustable from about 0.05 to 1 s
 - For AC input, adjustable from about 0.5 to 5 s
- For other specifications, please inquire.

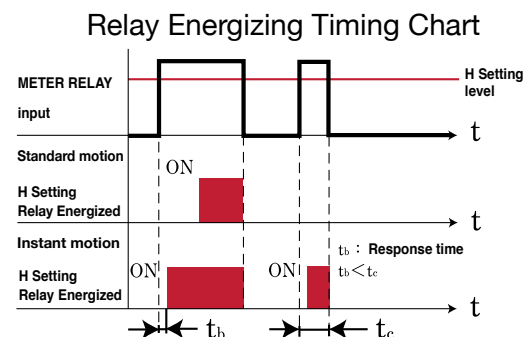

Time Constant: The time for the relay to energize after full-scale input is applied with the set point at about 63% of full scale.

Because the time is determined by time constant, when excessive input is close to the set value, the time until the relay energizes becomes longer than the set time. Also, larger excessive input results in shorter time to relay energizing.

-3. Recorder Connection Terminals

Analog output proportional to meter input is provided.
This allows recording during automatic control.

Specifications

1 volt f.s. (with 1 M Ω or more load resistance)
For other specifications, please inquire.



Note

Input and output are not isolated.

-4. Extended Scales

Extended scales are available to protect the meter from overcurrent during motor startup. Normally applicable only to AC ammeters.

Example 1. 30:5 A AC

2X over-scale extension (for 30:5 CT ratio)

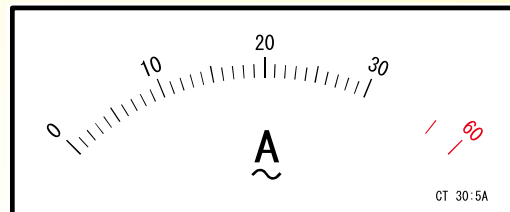

Example 2. 30:5 A AC

3X over-scale extension (for 30:5 CT ratio)

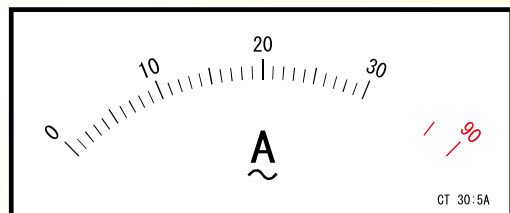

Note

Extended and expanded scales cannot be combined.

-5. Expanded Scales

A scale can be expanded to show 40% or more of the full-scale value (except for 4-20 mA and 1 to 5 V scales).

Example. When the full-scale value is 100 V,

$$100 \times 40\% = 40V$$

For a full-scale value of 100, the reading range can be expanded to a 40 V range.

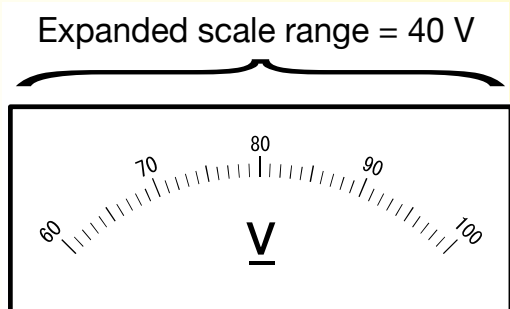

Note

Do not expect the sensitivity of the expanded range to exceed documented specifications. Expanded and extended scales cannot be combined.

-6. Manually Marked Scales

Custom scales can be marked or created by hand.

Example: A 3 A AC scale indicating 0 to 145%

R line present

Yellow Band: 100 to 115%

Red Band: 115 to 145%

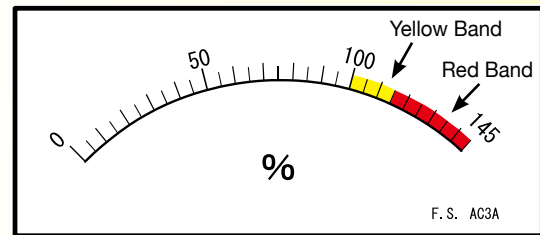

-7. Dual-Deflection Meters

The zero point can be positioned at the center of the scale. This is not available for AC input. The scale is not required to have regular gradations.

Example: ± 20 V DC

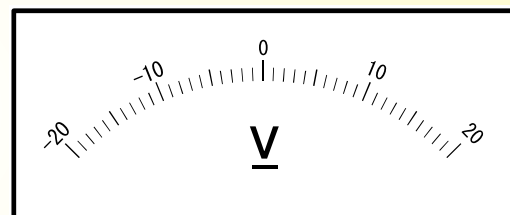

-8. Supply Voltage

100 V/200 VAC (to be specified at the time of ordering)

Other supply voltages available by special order are: 110, 120, 220, 230 and 240 V AC, and 12 or 24 V DC. For DC supply voltage, terminal polarity is as shown at the right.



Note

Please specify when ordering, because each model accepts only one supply voltage.

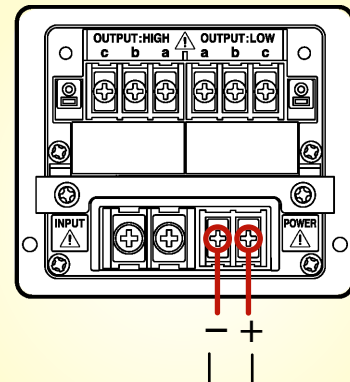

Power Supply Terminals

-9. Miscellanea

- Meter indicator accuracy class 1.5 (2103)
- Custom scale divisions and units
- Reception indicating meter
- Rms versions of AC ammeters and AC voltmeters

These are available. Please inquire.

Note: Company names and Product names appearing in this catalog are trademarks or registered trademarks of various companies.

HIOKI

HIOKI E. E. CORPORATION

HEADQUARTERS:

81 Koizumi, Ueda, Nagano, 386-1192, Japan
TEL +81-268-28-0562 FAX +81-268-28-0568
<http://www.hioki.com/> / E-mail: os-com@hioki.co.jp

HIOKI USA CORPORATION:

TEL +1-609-409-9109 FAX +1-609-409-9108
<http://www.hiokiusa.com/> / E-mail: hioki@hiokiusa.com

HIOKI (Shanghai) SALES & TRADING CO., LTD.:
TEL +86-21-63910090 FAX +86-21-63910360
<http://www.hioki.cn/> / E-mail: info@hioki.com.cn

HIOKI INDIA PRIVATE LIMITED:
TEL +91-124-6590210 FAX +91-124-6460113
E-mail: hioki@hioki.in

HIOKI SINGAPORE PTE. LTD.:
TEL +65-6634-7677 FAX +65-6634-7477
E-mail: info@hioki.com.sg

HIOKI KOREA CO., LTD.:
TEL +82-42-936-1281 FAX +82-42-936-1284
E-mail: info-kr@hioki.co.jp

DISTRIBUTED BY